



# Integration Guide for Directional MEMS Microphones

## Introduction

Soundskrit has released the first high-performance directional MEMS microphones to provide high directivity and SNR in a convenient MEMS form factor. When integrating these microphones into end-products, choosing the best configuration for your requirements will ensure microphone performance and the benefits of a directional microphone. This document will introduce the key integration considerations of Soundskrit’s directional MEMS microphones, such as the SKR0400, and build intuition around how to use these microphones in products.

If you need further help in designing your products with the SKR0400 for maximum performance, please reach out to us and we are happy to assist you.

## Microphone Sealing

Creating a proper acoustic seal between the microphone and product casing is important. Improper sealing can degrade the performance of the microphone. For example, leakages may create unwanted resonances in the product or change the microphone’s directional response. Directional MEMS microphones are compatible with the sealing gaskets typically used with omnidirectional microphones, such as rubber or foam. To create an airtight seal, couple the gaskets to the product casing with compression or an adhesive layer. Integrating an acoustic mesh between the gasket and product casing will provide additional protection from water or particulate ingress. All else being equal, meshes with a larger pore size will reduce the impact on microphone sensitivity, but provide less protection.

## Integration Configurations

Unlike traditional omnidirectional microphones, directional microphones have two sound ports as illustrated in Figure 1 below. The sound ports are in the lid and the PCB of the microphone. In a product, each sound port must be properly coupled to a sound port in the product’s casing. There are three main methods for connecting the sound ports of a Soundskrit microphone to the exterior of a product.

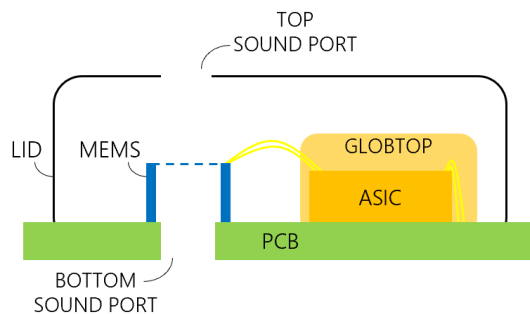
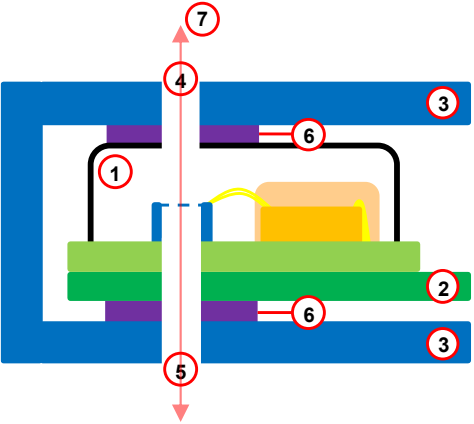

Figure 1: Cross-section of Soundskrit directional MEMS microphone

### The “Thru-hole” Configuration



1	SKR0400 Microphone
2	Product PCB
3	Product Casing
4	Top Sound Port
5	Bottom Sound Port
6	Sealing Gaskets
7	Direction of Sensitivity

Figure 2: Cross-section schematic of the thru-hole configuration

The simplest implementation method is the “thru-hole” configuration. This configuration simply uses a sound port in the front and back of the product with an acoustic channel going straight through the product to connect the two. Figure 2 illustrates a schematic of the thru-hole configuration. In Figure 2, the microphone<sup>1</sup> is mounted onto the product’s PCB<sup>2</sup> and coupled to the product’s casing<sup>3</sup>. The casing has a top sound port<sup>4</sup> and a bottom sound port<sup>5</sup>. Sealing gaskets<sup>6</sup> are used to couple the sound ports of the product to the sound ports of the microphone. The thru-hole configuration has a direction of sensitivity as indicated by the arrow<sup>7</sup>.

### The “V” Configuration

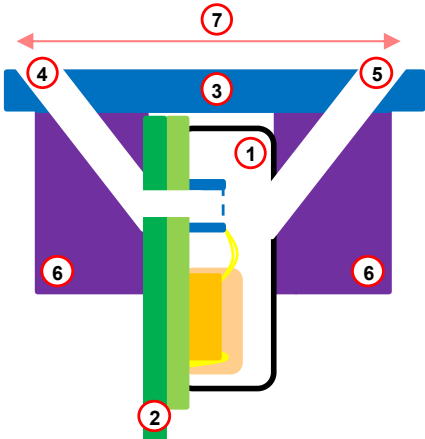

1	SKR0400 Microphone
2	Product PCB
3	Product Casing
4	Top Sound Port
5	Bottom Sound Port
6	Sealing Gaskets
7	Direction of Sensitivity

Figure 3: Cross-section schematic of the V configuration

It is often desirable to have both sound ports on the same surface. To achieve this, the microphone can be integrated using a “V” configuration where bent acoustic channels bring the sound ports to the surface. Figure 3 illustrates a schematic of the V configuration. The direction of sensitivity<sup>7</sup> is now rotated such that it is sensitive to sounds traveling along the axis connecting the sound ports<sup>4, 5</sup>, parallel to the product casing<sup>3</sup>.

### The “L” Configuration

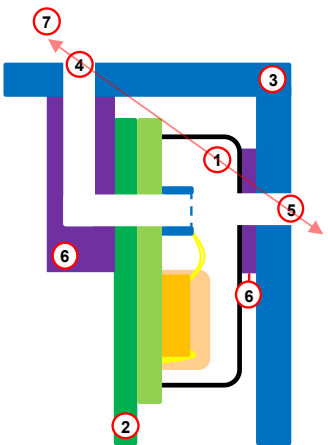

1	SKR0400 Microphone
2	Product PCB
3	Product Casing
4	Top Sound Port
5	Bottom Sound Port
6	Sealing Gaskets
7	Direction of Sensitivity

Figure 4: Cross-section schematic of the L configuration

Using a combination of the above techniques, sound ports can be placed on adjacent surfaces when near an edge or corner. This configuration uses a bent acoustic channel in the shape of an “L” and is illustrated in Figure 4 above. the direction of sensitivity<sup>7</sup> of the microphone is now rotated such that it is sensitive to sounds traveling along the axis connecting the sound ports<sup>4, 5</sup>, tilted relative to the configuration in Figure 3.

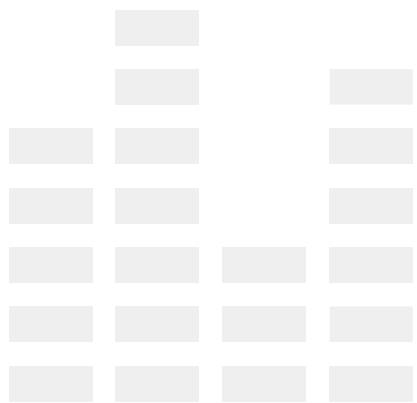

## Acoustic Path Length

The acoustic path length of a directional microphone embedded inside a product is the distance it takes a sound wave to travel from the first sound port to the second. The larger the acoustic path length, the larger the pressure difference that is created at the two sound ports of the microphone. This increases the sensitivity/SNR. For more information describing the acoustic path length, please refer to [AN-110 – Attributes of Soundskrit Microphones](#)

The acoustic path for each of the previous configurations described is illustrated in Figure 5. When these microphones are integrated into larger products, the acoustic path length may vary as there can be several different acoustic paths the sound may take when traveling between the two sound ports. If they are not all symmetric, then the exact acoustic path length may deviate.

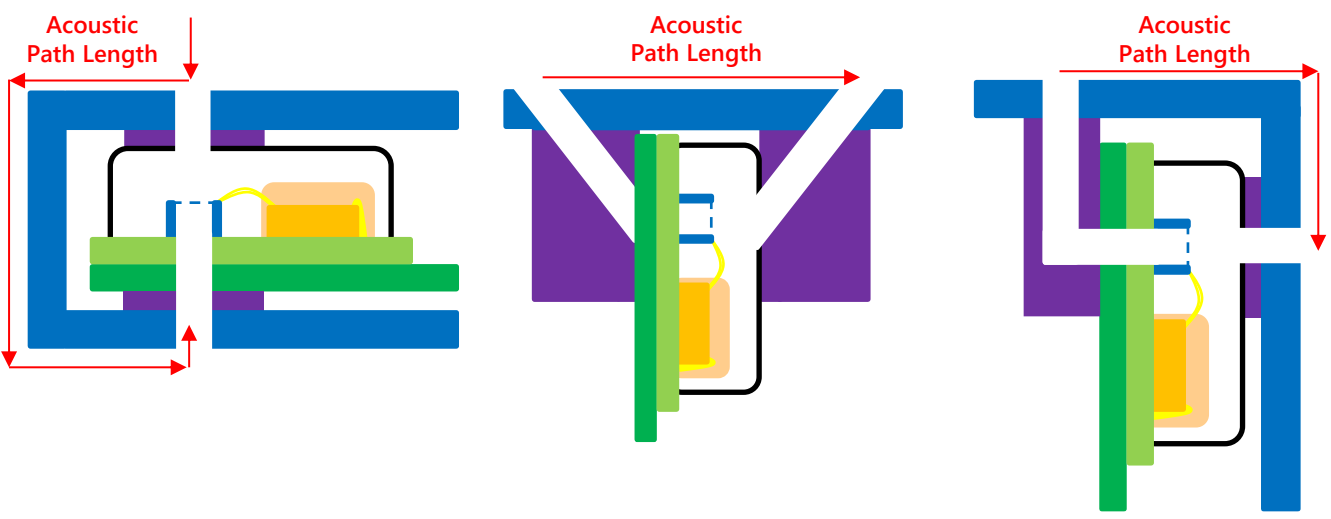

Figure 5: Acoustic path (red) for the thru-hole (left), V (middle), and L (right) configurations

The SKR0400 is specified with a 10mm acoustic path length and 63.5dB SNR. Thus, to maintain at least 63.5dB SNR, it is recommended to ensure that the acoustic path (drawn in red in Figure 5) is set to be at least 10mm. Larger acoustic path lengths will lead to a gain in sensitivity, while shorter path lengths will lead to a reduction in sensitivity. A gain in sensitivity leads to a corresponding gain in SNR and a loss in acoustic overload point (AOP). The acoustic path length should be designed in a product accordingly to give the desired performance.

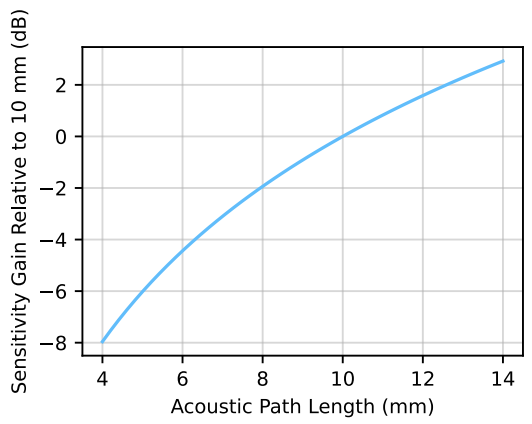

Figure 6: SKR0400 sensitivity as a function of acoustic path length

Figure 6 shows the gain/reduction in microphone sensitivity in response to different acoustic path lengths relative to the performance at the specified 10mm standard.

It should be noted that for acoustic paths above 14mm, the sensitivity of the microphone will continue to increase. However, as path lengths of this size become on the same order of magnitude as the wavelength of audio frequencies, the frequency response and sensitivity may be affected at higher frequencies. In general, it is recommended to design an acoustic path length of around 8-12mm.

## Acoustic Channel Length

The acoustic channel length corresponds to the length of the acoustic channel going through (inside) the product in which the microphone is embedded. Acoustic channels experience resonances that compromise the directionality of the microphone.

The acoustic channel for each of the previous 3 configurations described is illustrated in Figure 7.

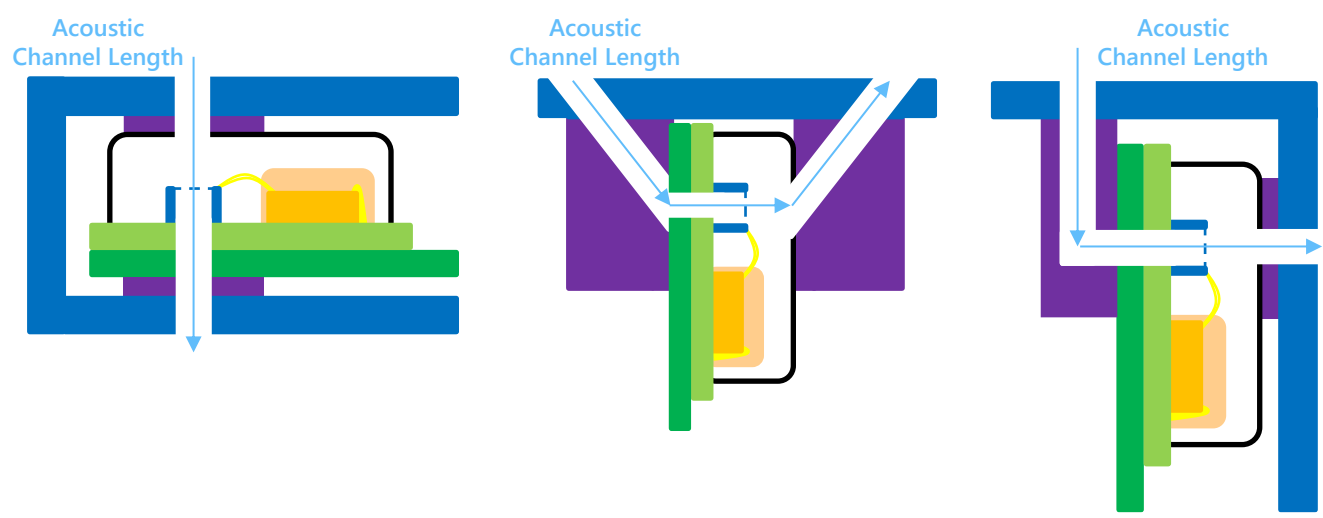

Figure 7: Acoustic channel (blue) for the thru-hole (left), V (middle), and L (right) configurations

The smaller the acoustic channel length, the higher the resonance. Thus, it is desirable to minimize the acoustic channel length as much as possible to maintain directionality.

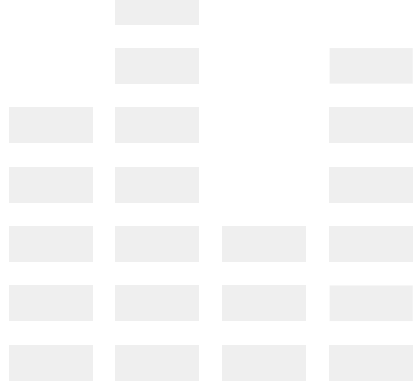

Figure 8 shows the resonant frequency of different acoustic channel lengths. For applications in which 20kHz bandwidth is not needed (i.e., for speech recognition that only records audio up to 8kHz), larger acoustic channel lengths may be used. It turns out, the microphone may start to lose directionality before the channel resonance. Thus, the acoustic channel length should be set so that its resonance is above the highest frequency of desired sound capture. In general, it is recommended to maintain an acoustic channel length of less than 6mm for applications requiring up to 20kHz directional sound capture and less than 17mm for applications only needing directionality up to 8kHz.

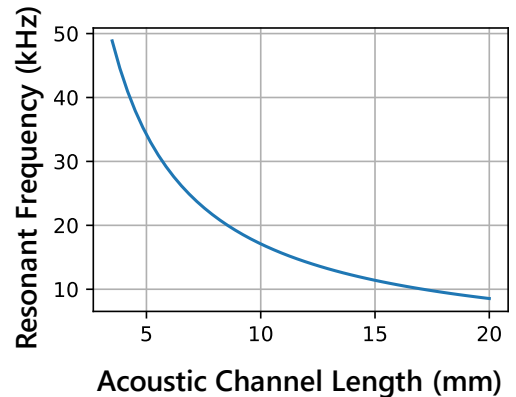

Figure 8: Resonant frequency vs. acoustic channel length

## Choosing the Best Configuration

When deciding the best way to integrate directional microphones into an end-product, one should follow a set of steps:

1. Determine microphone system needs (i.e., how many microphones are needed, which directions should they point, etc.)
2. Determine microphone placement needs (i.e., through-hole, V-shape, L-shape)
3. Determine acoustic channel length
4. Determine acoustic path length
5. Determine gasket sealing
6. Determine possible mesh protection

Below is a table summarizing the recommendations for the three microphone configurations discussed:

<b>General</b>	For 20kHz directionality: <ul style="list-style-type: none"> <li>• Acoustic path length of 10mm</li> <li>• Acoustic channel length of &lt;6mm</li> </ul> For 8kHz directionality: <ul style="list-style-type: none"> <li>• Acoustic path length of 10 mm</li> <li>• Acoustic channel length of &lt;17mm</li> </ul>
<b>Through-hole</b>	<ul style="list-style-type: none"> <li>• This configuration can be very convenient for thin products.</li> <li>• A special slanted through hole configuration can also be used.</li> <li>• Mesh with 15-40rayls can be used</li> </ul>
<b>V-configuration</b>	<ul style="list-style-type: none"> <li>• Acoustic channel lengths of 11-15mm are achievable in thin products</li> <li>• Is robust to ingress without a mesh, although a mesh can be used for further protection</li> <li>• Port holes should be larger than 1.3mm, 1.5mm or larger is recommended</li> </ul>
<b>L-configuration</b>	<ul style="list-style-type: none"> <li>• The paths on both sides of the microphone should be similar in length. If one side must be longer, It should be the side opposite of the sound source of interest.</li> <li>• Mesh with 15-40rayls can be used</li> </ul>

Figure 9: Recommendation summary for microphone integration

## Conclusion

As shown, the SKR0400 can be implemented in several different ways depending on the product requirements. By bending the acoustic channel, sound ports can be placed on any surface of an end-product. It is important that sufficient spacing is maintained between the sound ports in the end-product, but also not excessively so. By setting the acoustic path and acoustic channel lengths as described in this document, SNR and directionality can be preserved in the end-product to provide high-quality sound capture.

## Additional Support

For further information on Soundskrit’s products, visit our website at <http://www.soundskrit.ca> where you can find more application notes, datasheets, and purchasing information. If you have any questions or need technical support, please reach out to [applications@soundskrit.ca](mailto:applications@soundskrit.ca).

Revision Label	Revision Date	Sections Revised
-	November 2022	Initial release





## ABOUT US

Soundskrit has developed the world's first bio-inspired high-performance directional microphone that eliminates background noise and reverberation. Our intuitive sensory technology isolates the speaker's voice from all other ambient sounds, creating immersive audio experiences. Soundskrit replaces traditional microphone arrays in a wide range of devices and consumer electronics, including laptops, webcams, headsets, conference systems, smart home devices, smartphones, hearing aids, wearables and more.

Soundskrit was founded in 2019 and is headquartered in Montreal, Quebec with an R&D facility in Ann Arbor, Michigan.

